



Multicontactos con supresor de picos, puertos USB tipo A y C carga rápida **VOLTECK**

- Fabricados en policarbonato  
- Puertos de carga USB de 15 W

X1 USB-A X1 / Carga rápida USB-C

10% DESCUENTO

Pág. 427



Promo.	Mayoreo	Código	Clave	Contactos	Protección	NC
\$193.50	\$215	45748	MUL-352U	3	Media 490 J	3
\$206.10	\$229	45747	MUL-682U	6	Alta 800 J	3

Caja 4 / Máster 24 / **MM 00**

Multicontactos, puertos USB tipo A y C carga rápida **VOLTECK**

- Fabricados en policarbonato  
- Puertos de carga USB de 15 W

X1 USB-A X1 / Carga rápida USB-C

10% DESCUENTO

Pág. 427



Promo.	Mayoreo	Código	Clave	Contactos	NC
\$148.50	\$165	45836	MUL-202U	2	3
\$179.10	\$199	45749	MUL-302U	3	3

Caja 4 / Máster 24 / **MM 00**

Placas con interruptores **VOLTECK Basic** Línea Toledo

- Fabricadas en policarbonato



10% DESCUENTO

Pág. 409

Promo.	Mayoreo	Código	Clave	Descripción	NC
\$22.50	\$25	29052	PA-APSE15-TB	1 Interruptor sencillo, 1,5 módulos	3
\$27	\$30	29055	PA-TI-TB	1 Timbre, 1,5 módulos	3
\$27	\$30	29056	PA-APSE15-ETB	1 Interruptor 3 vías, 1,5 módulos	3
\$33.30	\$37	29053	PA-APD015-TB	2 Interruptores sencillos, 1,5 módulos	3
\$38.70	\$43	29059	PA-APD015-ETB	1 Interruptor 3 vías, 1,5 módulos	3
\$45	\$50	29054	PA-APTR-TB	3 Interruptores sencillos, 1 módulo	3

Caja 10 / Máster 100 / **MM 00**

Placas con contactos, interruptor y 2 puertos USB **VOLTECK Basic** Línea Toledo

- Fabricadas en policarbonato



10% DESCUENTO

Pág. 409

Promo.	Mayoreo	Código	Clave	Caja	Máster	Descripción	NC
\$40.50	\$45	29058	PA-APC015-TB	10	100	1 Interruptor sencillo y 1 contacto, 1,5 módulos	3
\$33.30	\$37	29057	COD0-TB	10	100	2 Contactos, 3 módulos	3
\$152.10	\$169	29062	COUSB-TB	3	72	1 Contacto y 2 puertos USB, 1,5 módulos	3

**MM 00**

Placas con toma de televisión y teléfono **VOLTECK Basic** Línea Toledo

- Fabricadas en policarbonato

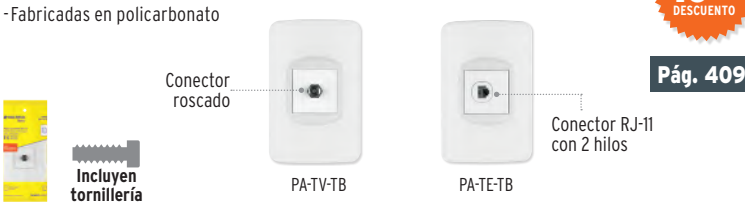

10% DESCUENTO

Pág. 409

Promo.	Mayoreo	Código	Clave	Descripción	NC
\$26.10	\$29	29060	PA-TV-TB	1 Toma de televisión, 1,5 módulos	3
\$26.10	\$29	29061	PA-TE-TB	1 Toma de teléfono, 1,5 módulos	3

Caja 3 / Máster 72 / **MM 00**

Placas **VOLTECK Basic** Línea Toledo

- Fabricadas en policarbonato



10% DESCUENTO

Pág. 409

Promo.	Mayoreo	Código	Clave	Descripción	NC
\$10.80	\$12	29042	PPSE15-TB	1 Ventana, 1,5 módulos	3
\$10.80	\$12	29043	PPTR-TB	1 Ventana, 3 módulos	3

Caja 10 / Máster 200 / **MM 00**

Contacto sencillo 2 polos + tierra **VOLTECK Basic** Línea Toledo

- Fabricado en policarbonato  
- Medida del módulo: 1.5 (36 mm)

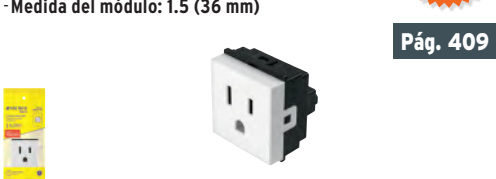

10% DESCUENTO

Pág. 409

Promo.	Mayoreo	Código	Clave	NC
\$19.80	\$22	29047	COA15-TB	3

Caja 10 / Máster 100 / **MM 00**

Interruptores **VOLTECK Basic** Línea Toledo

- Fabricados en policarbonato  
- Medida del módulo: 1.5 (36 mm)

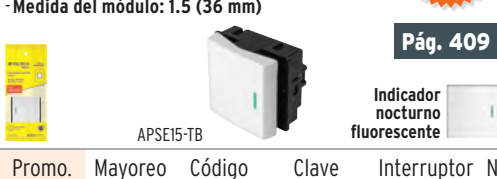

10% DESCUENTO

Pág. 409

Promo.	Mayoreo	Código	Clave	Interruptor	NC
\$13.05	\$14.50	29044	APSE15-TB	Sencillo	3
\$18	\$20	29045	APSE15-ETB	3 vías	3
\$18	\$20	29046	APTI15-TB	Timbre	3

Caja 10 / Máster 100 / **MM 00**

Atenuador de luz rotativo **VOLTECK Basic** Línea Toledo

- Fabricado en policarbonato  
- Medida del módulo: 1.5 (36 mm)  
- Permite regular la intensidad de la luz  
- Potencia máxima: 300 W



10% DESCUENTO

Pág. 409

Promo.	Mayoreo	Código	Clave	NC
\$76.50	\$85	29050	DIM15-TB	3

Caja 3 / Máster 100 / **MM 00**

Toma con 2 puertos USB **VOLTECK Basic** Línea Toledo

- Fabricada en policarbonato  
- Medida del módulo: 1.5 (36 mm)



10% DESCUENTO

Pág. 409

Promo.	Mayoreo	Código	Clave	NC
\$121.50	\$135	29051	C2USB-TB	3

Caja 3 / Máster 100 / **MM 00**

Toma de televisión **VOLTECK Basic** Línea Toledo

- Fabricada en policarbonato  
- Medida del módulo: 1.5 (36 mm)

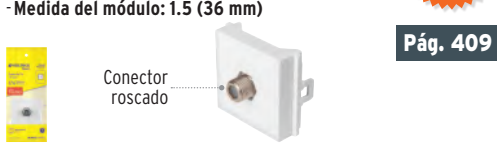

10% DESCUENTO

Pág. 409

Promo.	Mayoreo	Código	Clave	NC
\$15.30	\$17	29048	TV15-TB	3

Caja 10 / Máster 100 / **MM 00**

Toma de teléfono **VOLTECK Basic** Línea Toledo

- Fabricada en policarbonato  
- Medida del módulo: 1.5 (36 mm)

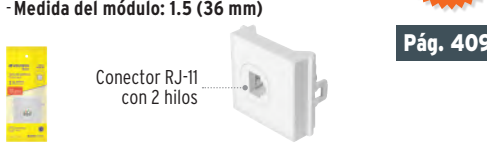

10% DESCUENTO

Pág. 409

Promo.	Mayoreo	Código	Clave	NC
\$15.30	\$17	29049	TE15-TB	3

Caja 10 / Máster 100 / **MM 00**

**Filtro de agua para regadera FOSET**

- Mejora la calidad del agua
- Incluye 1 cartucho de repuesto y cinta sella rosca

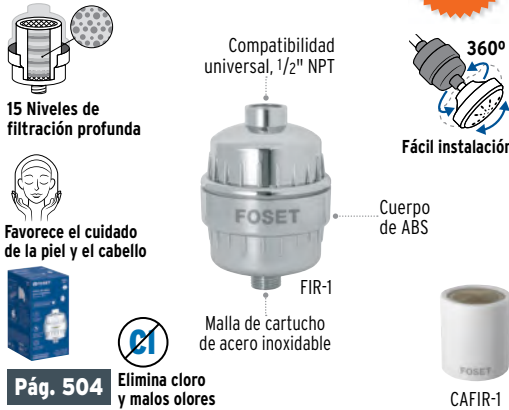

**10% DESCUENTO**

Promo.	May.	Código	Clave	Descripción	NC
\$346.50	\$385	45854	FIR-1	Filtro	3

Caja 2 / Máster 30 / **MM 00**

Promo.	May.	Código	Clave	Descripción	NC
\$112.50	\$125	45855	CAFIR-1	Cartucho	3

Caja 6 / Máster 60 / **MM 00**

**Llave de esfera de seguridad, cuerpo de latón FOSET**

- Maneral giratorio 360°
- Peso: 168 g

**10% DESCUENTO**

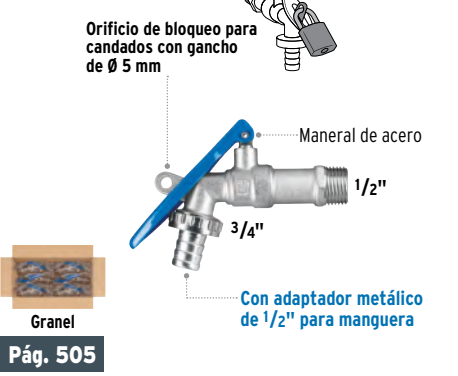

Promo.	Mayoreo	Código	Clave	NC
\$87.30	\$97	45746	LLE-175L	2

Caja 6 / Máster 48 / **MM 00**

**Cuellos flexibles para mezcladoras de fregadero FOSET Agua**

- Fabricados en acero inoxidable
- Largo total: 55 cm

**5% DESCUENTO**



Promo.	May.	Código	Clave	Para	Acabado	NC
\$166.25	\$175	45885	AOCR-81N	AOF-88N	Satín	3
\$160.55	\$169	45948	AOCR-81M	AOF-88M	Negro mate	3

Mínimo a surtir 1 / Caja 2 / Máster 12 / **MM 00**

**Tubería semiflexible multicapa, en rollo de 25 m, precio por metro FOSET GAS**

- Tubería ligera y fácil de transportar
- Uso interior y exterior

Disponibles a partir de la 2a. semana

**10% DESCUENTO**



Promo.	May.	Ref. Precio por rollo	Código	Clave	Diámetro nominal	NC
\$22.50	\$25	\$625	44828	PPG-3825	3/8" (16 mm)	3
\$31.50	\$35	\$875	44840	PPG-1225	1/2" (20 mm)	3
\$49.50	\$55	\$1,375	44841	PPG-3425	3/4" (25 mm)	3

**MM 00**

**Válvula horizontal 1/8" para gas LP, alta presión FOSET**

- Presión de trabajo con regulador de gas: 2.75 kPa / 0.40 psi
- Rosca macho NPT 1/8"
- Esprea no. 70

**10% DESCUENTO**



Promo.	Mayoreo	Código	Clave	NC
\$64.80	\$72	45443	VGH-557	3

Caja 6 / Máster 36 / **MM 00**

**Candado metálico para freno de disco de motocicleta, con alarma FIERO**

- Extensión máxima de cable: 1.50 m

**10% DESCUENTO**



Promo.	Mayoreo	Código	Clave	NC
\$490.50	\$545	45863	CB-70A	2

Caja 2 / Máster 24 / **MM 00**

**Tuercas cople FIERO**

- Ideales para instalaciones en suspensión

**10% DESCUENTO**



Promo.	May.	Código	Clave	Ø	Largo	Pzas.	NC
\$7.20	\$8	40942	TUEC-3/16	3/16"	3/4" (19 mm)	5	3
\$8.10	\$9	40943	TUEC-1/4	1/4"	13/16" (19 mm)	5	3
\$22.50	\$25	40944	TUEC-5/16	5/16"	1" (25 mm)	5	3
\$26.10	\$29	40945	TUEC-3/8	3/8"	1 1/8" (28 mm)	5	3
\$32.40	\$36	40946	TUEC-7/16	7/16"	1 1/4" (31 mm)	5	3
\$35.10	\$39	40947	TUEC-1/2	1/2"	1 1/4" (31 mm)	5	3
\$53.10	\$59	40948	TUEC-5/8	5/8"	2 1/8" (53 mm)	5	3
\$37.80	\$42	40949	TUEC-3/4	3/4"	2 1/4" (57 mm)	2	3
\$72	\$80	40950	TUEC-7/8	7/8"	2 1/2" (63 mm)	2	3
\$91.80	\$102	40951	TUEC-1	1"	2 1/2" (63 mm)	2	3

Bolsa 6 / Máster 24 / **MM 00**

**Tuercas de seguridad FIERO**

- Fabricadas en acero galvanizado

**10% DESCUENTO**



Promo.	May.	Código	Clave	Medida	Pzas.	NC
\$134.10	\$149	40910	TUEN-1/4	1/4"	250	3
\$103.50	\$115	40911	TUEN-5/16	5/16"	150	3
\$112.50	\$125	40912	TUEN-3/8	3/8"	100	3
\$76.50	\$85	40913	TUEN-7/16	7/16"	60	3
\$125.10	\$139	40914	TUEN-1/2	1/2"	50	3
\$121.50	\$135	40915	TUEN-9/16	9/16"	30	3
\$125.10	\$139	40916	TUEN-5/8	5/8"	25	3
\$112.50	\$125	40917	TUEN-3/4	3/4"	15	3
\$121.50	\$135	40918	TUEN-7/8	7/8"	10	3

Bolsa 6 / Máster 24 / **MM 00**

**Tuercas hexagonales, 7/8" y 1" FIERO**

- Fabricadas en acero galvanizado

**10% DESCUENTO**



Bolsa 6 / Máster 24 / **MM 00**

**Tuercas flange FIERO**

- Fabricadas en acero galvanizado

**10% DESCUENTO**

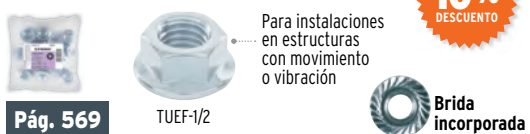

Promo.	May.	Código	Clave	Medida	Pzas.	NC
\$49.50	\$55	40936	TUEF-1/4	1/4"	100	3
\$53.10	\$59	40937	TUEF-5/16	5/16"	75	3
\$49.50	\$55	40938	TUEF-3/8	3/8"	50	3
\$57.60	\$64	40939	TUEF-1/2	1/2"	25	3
\$76.50	\$85	40940	TUEF-5/8	5/8"	15	3
\$81	\$90	40941	TUEF-3/4	3/4"	10	3

Bolsa 6 / Máster 24 / **MM 00**

**Arandelas planas, bolsa de 1 kg FIERO**

- Fabricadas en acero galvanizado

**10% DESCUENTO**



Bolsa 6 / Máster 18 / **MM 00**



### Aspiradora eléctrica canister, 1 L TRUPER

- Accesorios incluidos



**20%  
DESCUENTO**

Filtro de fácil extracción



Pág. 34

Código	Clave	Potencia	Promo.	Mayoreo	NC
103159	ASD-120	1.6 HP	\$868	\$1,085	1

Caja 1 / MM 1

### Bombas presurizadoras tipo Jet, con control automático TRUPER

- Cabezal de acero inoxidable



**20%  
DESCUENTO**

Código	Clave	Potencia	Promo.	Mayoreo	NC
102858	PRE-1/2I	1/2 HP	\$1,880	\$2,350	1

Caja 1 / MM 1

102857	PRE-II	1 HP	\$2,440	\$3,050	1
--------	--------	------	---------	---------	---

Caja 1 / MM 0

### Estante plástico, 4 repisas PRETUL

- Capacidad máxima de carga por estante: 175 kg  
- Capacidad máxima de carga por repisa: 45 kg

**10%  
DESCUENTO**



**HECHO EN MÉXICO**

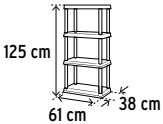

Código	Clave	Promo.	Mayoreo	NC
20682	EST-4P2	\$310.50	\$345	2

Caja 1 / MM 0

### Mini soldadoras inversoras, proceso SMAW y MMA PRETUL

INCLUYEN:

- Cable con pinza para tierra 1.9 m #5 AWG (16 mm<sup>2</sup>)
- Cable con pinza portaelectrodo 1.8 m #5 AWG (16 mm<sup>2</sup>)
- Cable de alimentación 2 m con clavija
- Careta plana (tipo paleta)
- Cepillo de alambre
- Correa

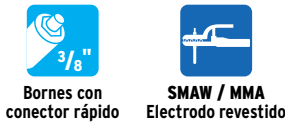

**10%  
DESCUENTO**



Referencia de estatura 1.70 m

**BV BI-VOLTAGE** Sistema de adaptación automática de voltaje

Pág. 372

Los primeros pedidos pueden venir con la clave SOIN-130MBP

Promo.:	<b>\$1,138.50</b>	<b>\$985.50</b>
Mayoreo:	<b>\$1,265</b> NC 1	<b>\$1,095</b> NC 1
Código:	<b>29019</b>	<b>29017</b>
Clave:	<b>SOIN-313MBP</b>	<b>SOIN-310MP</b>
Amperaje:	<b>130 A</b>	<b>100 A</b>

Dimensiones:

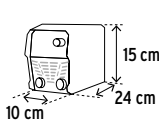
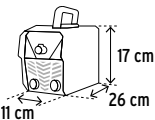

Caja: 1 / MM 0

### Hidrolavadora eléctrica, 1,350 psi PRETUL

- Accesorios incluidos



Pág. 177

Código	Clave	Promo.	Mayoreo	NC
29004	HILA-1350P	\$977.50	\$1,150	1

Caja 1 / MM 0

- Limpieza superficial
- Uso eficiente de agua **30X** más presión
- 40 m<sup>2</sup>/h
- 127 V/60Hz



**15%  
DESCUENTO**

Diseño ligero y portátil

### Esmeriladora angular inalámbrica, 20 V, 4 1/2" PRETUL

- Eje: 5/8-11-UCN-1A



Pág. 274

Código	Clave	Promo.	Mayoreo	NC
28267	ESMI-20P	\$1,525.50	\$1,695	1

Caja 1 / Máster 5 / MM 1

- 4 Ah **10N LITIO** Capacidad
- 0-7,100 rpm Velocidad
- Cargador 127 V / 60Hz



**10%  
DESCUENTO**

Guarda de ajuste rápido

### Llave de impacto inalámbrica, 20 V, 1/2" PRETUL

Impulsor de cuadro con pasador retenedor 1/2



Pág. 274

Código	Clave	Promo.	Mayoreo	NC
28268	LIMI-20P	\$1,336.50	\$1,485	1

Caja 1 / Máster 6 / MM 1

- 4 Ah **10N LITIO** Capacidad
- 0-2,200 rpm Velocidad
- Cargador 127 V / 60Hz



**10%  
DESCUENTO**

### Lijadora roto-orbital inalámbrica, 20 V, 5" PRETUL

- Diámetro de órbita: 2.7 mm  
- 6 velocidades



Pág. 274

Código	Clave	Promo.	Mayoreo	NC
28271	LIRI-20P	\$1,237.50	\$1,375	1

Caja 1 / Máster 6 / MM 1

- 2 Ah **10N LITIO** Capacidad
- 3,000-10,000 opm Velocidad
- Cargador 127 V / 60Hz



**10%  
DESCUENTO**

Operación a una mano

### Sierra caladora inalámbrica, 20 V PRETUL

- Acción pendular de 4 posiciones



Pág. 274

Código	Clave	Promo.	Mayoreo	NC
28270	CALI-20P	\$1,336.50	\$1,485	1

Caja 1 / Máster 5 / MM 1

- 2 Ah **10N LITIO** Capacidad
- 0-2,500 cpm Velocidad
- Cargador 127 V / 60Hz



**10%  
DESCUENTO**

### Destornillador inalámbrico, 1/4", 3.6 V PRETUL

Portapuntas magnético de 1/4"



Pág. 275

Código	Clave	Promo.	Mayoreo	NC
26402	DESI-36P2	\$224.10	\$249	1

Caja 2 / Máster 6 / MM 1

- 230 rpm Velocidad
- 30 lb/ft (3.5 Nm) Torque
- Cargador 127 V / 60Hz



**10%  
DESCUENTO**

Mango de doble posición

Mangueras súper reforzadas, **4 capas**, en rollos de 50 y 100 m, **precio por metro TRUPER PRO**



Pág. 228

Código	Clave	Diámetro	Largo	Promo.	Mayoreo	NC
Precio por metro (Referencia precio por rollo)						
102554	MAN-1/2XM	1/2"	50 m	<b>\$11.70</b> (\$585)	<b>\$13</b> (\$650)	3
19874*	MAN-1/2X	1/2"	100 m	<b>\$11.70</b> (\$1,170)	<b>\$13</b> (\$1,300)	3
19873	MAN-5/8X	5/8"	100 m	<b>\$16.20</b> (\$1,620)	<b>\$18</b> (\$1,800)	3
11127	MAN-3/4X	3/4"	100 m	<b>\$22.50</b> (\$2,250)	<b>\$25</b> (\$2,500)	3
11129	MAN-1X	1"	50 m	<b>\$35.10</b> (\$1,755)	<b>\$39</b> (\$1,950)	3



MAN-1/2X

MM 00

Mangueras reforzadas, **3 capas**, en rollos de 50 y 100 m, **precio por metro TRUPER Classic**



Pág. 228

Código	Clave	Diámetro	Largo	Promo.	Mayoreo	NC
Precio por metro (Referencia precio por rollo)						
102553	MAN-1/2RM	1/2"	50 m	<b>\$10.80</b> (\$540)	<b>\$12</b> (\$600)	3
19857*	MAN-1/2R	1/2"	100 m	<b>\$10.80</b> (\$1,080)	<b>\$12</b> (\$1,200)	3
19858	MAN-5/8R	5/8"	100 m	<b>\$15.30</b> (\$1,530)	<b>\$17</b> (\$1,700)	3
19859*	MAN-3/4R	3/4"	100 m	<b>\$19.80</b> (\$1,980)	<b>\$22</b> (\$2,200)	3
19875*	MAN-1R	1"	50 m	<b>\$32.40</b> (\$1,620)	<b>\$36</b> (\$1,800)	3



MAN-1/2R

MM 00

Mangueras reforzadas, **3 capas**, en rollos de 50 m y 100 m, **precio por metro PRETUL Casera**



Pág. 229

Código	Clave	Diámetro	Largo	Promo.	Mayoreo	NC
Precio por metro (Referencia precio por rollo)						
20658	MAN-1/2PRM	1/2"	50 m	<b>\$7.65</b> (\$382.50)	<b>\$8.50</b> (\$425)	2
25046*	MAN-1/2PR	1/2"	100 m	<b>\$7.65</b> (\$765)	<b>\$8.50</b> (\$850)	2
20598	MAN-5/8PR	5/8"	100 m	<b>\$10.80</b> (\$1,080)	<b>\$12</b> (\$1,200)	2
20599	MAN-3/4PR	3/4"	100 m	<b>\$13.95</b> (\$1,395)	<b>\$15.50</b> (\$1,550)	2
20601	MAN-1PR	1"	50 m	<b>\$24.30</b> (\$1,215)	<b>\$27</b> (\$1,350)	2



MAN-1/2PR

MM 0

Manguera reforzada, **3 capas**, en rollo de 100 m, **precio por metro PRETUL Básica**



Pág. 229

Código	Clave	Diámetro	Largo	Promo.	Mayoreo	NC
Precio por metro (Referencia precio por rollo)						
25035	MAN-1/2P	1/2"	100 m	<b>\$6.48</b> (\$648)	<b>\$7.20</b> (\$720)	2



MAN-1/2P

MM 0

Botas de seguridad, **color café, modelo 2024 PRETUL**



-Fabricadas en piel

Promoción especial para agotar el inventario del modelo 2024



Código	Clave	Talla Méx.	Promo.	Mayoreo	NC
27130	ZC-023C	23	<b>\$584.50</b>	<b>\$835</b>	2
27131	ZC-024C	24	<b>\$584.50</b>	<b>\$835</b>	2
25980	ZC-025C	25	<b>\$584.50</b>	<b>\$835</b>	2
25981	ZC-026C	26	<b>\$584.50</b>	<b>\$835</b>	2
25982	ZC-027C	27	<b>\$584.50</b>	<b>\$835</b>	2
25983	ZC-028C	28	<b>\$584.50</b>	<b>\$835</b>	2
25984	ZC-029C	29	<b>\$584.50</b>	<b>\$835</b>	2
25985	ZC-030C	30	<b>\$584.50</b>	<b>\$835</b>	2



Caja 1 / Máster 6 / MM 0

Botas de seguridad, **color negro, modelo 2024 PRETUL**



-Fabricadas en piel

Promoción especial para agotar el inventario del modelo 2024



Código	Clave	Talla Méx.	Promo.	Mayoreo	NC
26061	ZC-023N	23	<b>\$668</b>	<b>\$835</b>	2
26062	ZC-024N	24	<b>\$668</b>	<b>\$835</b>	2
25990	ZC-025N	25	<b>\$668</b>	<b>\$835</b>	2
25991	ZC-026N	26	<b>\$668</b>	<b>\$835</b>	2
25992	ZC-027N	27	<b>\$668</b>	<b>\$835</b>	2
25993	ZC-028N	28	<b>\$668</b>	<b>\$835</b>	2
25994	ZC-029N	29	<b>\$668</b>	<b>\$835</b>	2
25995	ZC-030N	30	<b>\$668</b>	<b>\$835</b>	2



Caja 1 / Máster 6 / MM 0

Sistema profesional de vigilancia CCTV con DVR, **5 MP, 4 canales VOLTECK**



-Video en tiempo real desde celular o tableta

- Incluye: 4 cámaras, 1 DVR, 1 cable tipo pulpo, 1 mouse, 2 adaptadores de corriente, 2 cables coaxiales tipo siamés de 30 m y 2 cables coaxiales tipo siamés de 20 m

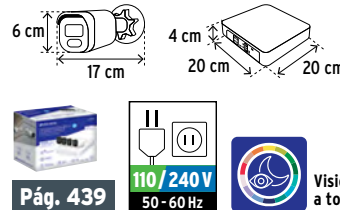

Pág. 439

110/240V  
50-60 Hz

Visión nocturna a todo color

Código	Clave	Promo.	Mayoreo	NC
49586	CTV-KIT-4A	<b>\$4,600</b>	<b>\$5,750</b>	1

Caja 1 / Máster 3 / MM 0

Cuerdas (piolas) de **sisal FIERO**



Pág. 557



Trenzado torcido

Biodegradables

NC 2

Código	Clave	Diámetro	Carga de trabajo	Peso	Encogible	Máster	Promo.	May.
<b>Rollos de 30 m</b>								
45656	PIO-630S	6 mm (1/4")	30 kg	540 g	6	18	<b>\$100</b>	<b>\$125</b>
45658	PIO-830S	8 mm (5/16")	40 kg	930 g	3	12	<b>\$180</b>	<b>\$225</b>
45660	PIO-1030S	10 mm (3/8")	60 kg	1,500 g	3	9	<b>\$263.20</b>	<b>\$329</b>

MM 00

**Rollos de 15 m**

45655	PIO-615S	6 mm (1/4")	30 kg	270 g	9	36	<b>\$52</b>	<b>\$65</b>
45657	PIO-815S	8 mm (5/16")	40 kg	465 g	6	18	<b>\$92</b>	<b>\$115</b>
45659	PIO-1015S	10 mm (3/8")	60 kg	750 g	3	12	<b>\$140</b>	<b>\$175</b>

MM 00



PIO-1030S



PIO-1015S

# ACTUALIZACIÓN DE PRECIOS DE ALTA VOLATILIDAD

El convenio de precio mínimo para productos de alta volatilidad aplica a partir del segundo día hábil del mes.

**AUMENTO DE PRECIO EN COLOR AZUL**

**REDUCCIÓN DE PRECIO EN COLOR VERDE**

**PRECIO SIN CAMBIO EN COLOR BLANCO**

**MAYO 2025**

## Bombas eléctricas para agua periféricas 1/2 HP

**Pág. 43**

**PRETUL**

**USO AGRÍCOLA SIN IVA**

Código	Clave	Altura máxima	Dist.	Mayoreo	1/2 Mayoreo	Púb.	NC
27019	BOAP-1/2P3	20 m	\$345	\$375	\$415	\$455	1

Caja 1 / Máster 6 / MM 1

**FOSET**

Código	Clave	Altura máxima	Dist.	Mayoreo	1/2 Mayoreo	Púb.	NC
49877	BOAP-1/2F	25 m	\$365	\$399	\$445	\$485	1
46237	BOAP-1/2F2	30 m	\$385	\$425	\$465	\$515	1

Caja 1 / Máster 6 / MM 1



Precios sin cambio

## Soldaduras TRUPER

**Pág. 376**

Precios sin cambio

Código	Clave	Uso	Dist.	Mayoreo	1/2 Mayoreo	Púb.	NC
<b>Soldaduras con núcleo de resina</b>							
14367	SOL-95/5	Tubería de gas	\$875	\$1,050	\$1,150	\$1,275	2
14365	SOL-50/50	Tubería de alta presión	\$355	\$425	\$465	\$515	2
14366	SOL-60/40	Electrónica	\$520	\$625	\$685	\$755	2

Caja 2 / Máster 12 / MM 0

**Soldaduras sólidas**

12282	SOL-95/5S	Tubería de gas	\$875	\$1,050	\$1,150	\$1,275	2
12284	SOL-50/50S	Tubería de alta presión	\$355	\$425	\$465	\$515	2
12283	SOL-1/2-1/2S	Tubería de baja presión	\$255	\$305	\$335	\$375	2

Caja 2 / Máster 12 / MM 0

**Soldaduras sólidas en blíster**

13289	SOL-95/5M	Tubería de gas	\$99	\$129	\$142	\$155	3
13288	SOL-50/50M	Tubería de alta presión	\$58	\$75	\$82	\$92	3
13287	SOL-1/2-1/2M	Tubería de baja presión	\$50	\$65	\$72	\$79	3

Caja 12 / Máster 96 / MM 0



## Escaleras tipo tijera TIPO II TRUPER

**Pág. 148**

**CAPACIDAD DE CARGA 175 kg**

Precios sin cambio

Código	Clave	Peldaños	Altura	Distribuidor	Mayoreo	1/2 Mayoreo	Público	NC
10435	EST-23	3	1.2 m	\$1,050	\$1,250	\$1,400	\$1,550	2
10264	EST-24	4	1.5 m	\$1,350	\$1,600	\$1,800	\$1,950	2
10335	EST-25	5	1.8 m	\$1,500	\$1,800	\$2,000	\$2,150	2
16744	EST-26	6	2.1 m	\$1,800	\$2,150	\$2,350	\$2,600	2
10337	EST-27	7	2.4 m	\$2,000	\$2,400	\$2,650	\$2,900	2
10338	EST-28	8	2.7 m	\$2,300	\$2,750	\$3,050	\$3,350	2
10436	EST-29	9	3 m	\$2,600	\$3,150	\$3,450	\$3,750	2

Inner 1 / MM 00



EST-25

## Escaleras de extensión TIPO II TRUPER

**Pág. 150**

**CAPACIDAD DE CARGA 175 kg**

Precios sin cambio

Código	Clave	Peldaños	Altura extendida	Dist.	Mayoreo	1/2 Mayoreo	Púb.	NC
16758	ESE-220	20	4.9 m	\$3,800	\$4,550	\$5,000	\$5,550	2
16759	ESE-224	24	6.1 m	\$4,700	\$5,650	\$6,250	\$6,850	2

Inner 1 / MM 00



ESE-224

## Escaleras tipo tijera TIPO III TRUPER

**Pág. 148**

**CAPACIDAD DE CARGA 150 kg**

Precios sin cambio

Código	Clave	Peldaños	Altura	Distribuidor	Mayoreo	1/2 Mayoreo	Público	NC
16740	EST-32	2	0.9 m	\$750	\$900	\$990	\$1,100	2
16741	EST-33	3	1.2 m	\$900	\$1,100	\$1,200	\$1,300	2
16742	EST-34	4	1.5 m	\$1,150	\$1,400	\$1,500	\$1,650	2
16743	EST-35	5	1.8 m	\$1,275	\$1,550	\$1,700	\$1,850	2
10437	EST-36	6	2.1 m	\$1,550	\$1,850	\$2,050	\$2,250	2

Inner 1 / MM 00



EST-35

## Escaleras de extensión TIPO III TRUPER

**Pág. 150**

**CAPACIDAD DE CARGA 150 kg**

Precios sin cambio

Código	Clave	Peldaños	Altura extendida	Dist.	Mayoreo	1/2 Mayoreo	Púb.	NC
16026	ESE-16	16	3.8 m	\$2,400	\$2,900	\$3,150	\$3,500	2
16027	ESE-20	20	4.9 m	\$3,000	\$3,600	\$3,950	\$4,350	2
16028	ESE-24	24	6.1 m	\$3,550	\$4,250	\$4,650	\$5,150	2
16748	ESE-28	28	7.3 m	\$4,800	\$5,750	\$6,350	\$6,950	2

Inner 1 / MM 00



ESE-24

Cables THHW-LS, precio por metro en carrete de 500 m VOLTECK

Ahorra 8% comparado con la presentación de rollos chicos

Precios sin cambio

Table with 8 columns: Código, Clave, Calibre, Color, Distrib., Mayoreo, 1/2 Mayoreo, Público. Rows include codes like 40116 CAB-14N-500, 40117 CAB-12N-500, etc.

Table with 8 columns: Código, Clave, Calibre, Color, Distrib., Mayoreo, 1/2 Mayoreo, Público. Rows include codes like 40124 CAB-14R-500, 40125 CAB-12R-500, etc.

Cables THHW-LS, precio por rollo de 100 m VOLTECK

Ahorra 8% comparado con la presentación de rollos chicos

Precios sin cambio

Table with 8 columns: Código, Clave, Calibre, Color, Máster Rollo (Metros), Distrib., Mayoreo, 1/2 Mayoreo, Público. Rows include codes like 46053 CAB-14N, 46052 CAB-12N, etc.

Table with 8 columns: Código, Clave, Calibre, Color, Máster Rollo (Metros), Distrib., Mayoreo, 1/2 Mayoreo, Público. Rows include codes like 46061 CAB-14R, 46060 CAB-12R, etc.

Cables THHW-LS, precio por rollo de 10 m, 20 m y 25 m VOLTECK

Precios sin cambio

Table with 9 columns: Código, Clave, Calibre, Metros x Rollo, Color, Caja (Metros), Máster Rollo (Metros), Distrib., Mayoreo, 1/2 Mayoreo, Público. Rows include codes like 40148 CAB-14N-25, 40145 CAB-12N-20, etc.

Table with 9 columns: Código, Clave, Calibre, Metros x Rollo, Color, Caja (Metros), Máster Rollo (Metros), Distrib., Mayoreo, 1/2 Mayoreo, Público. Rows include codes like 40150 CAB-14R-25, 40147 CAB-12R-20, etc.

Cables CCA, precio por rollo de 100 m VOLTECK Basic

Precios sin cambio

Table with 8 columns: Código, Clave, Calibre, Color, Caja (Metros), Máster Rollo (Metros), Distrib., Mayoreo, 1/2 Mayoreo, Público. Rows include codes like 40217 CCA-14N, 40213 CCA-12N, etc.

Table with 8 columns: Código, Clave, Calibre, Color, Caja (Metros), Máster Rollo (Metros), Distrib., Mayoreo, 1/2 Mayoreo, Público. Rows include codes like 40218 CCA-14R, 40214 CCA-12R, etc.

La información e imágenes contenidas, pueden cambiar sin previo aviso por motivos de actualización y mejora continua. Sin responsabilidad de quien los publica o los produce. Todos nuestros productos incluyen IVA y cuentan con garantía.

Todos los Derechos Reservados, D.R., ©, TRUPER, S.A. de C.V. 2025. Queda prohibida la reproducción total o parcial, sin la autorización previa, expresa y por escrito de su titular



### Cordones uso extra rudo, 3 conductores, precio por metro en rollo de 100 m VOLTECK

Precios sin cambio

Pág. 413



Código	Clave	Calibre	Distribuidor	Mayoreo	1/2 Mayoreo	Público	NC
40005	CAUR-310	3 x 10 AWG	\$72 (\$7,200)	\$79 (\$7,900)	\$87 (\$8,700)	\$95 (\$9,500)	1
40006	CAUR-312	3 x 12 AWG	\$47 (\$4,700)	\$52 (\$5,200)	\$57 (\$5,700)	\$62 (\$6,200)	1
40007	CAUR-314	3 x 14 AWG	\$32 (\$3,200)	\$35 (\$3,500)	\$39 (\$3,900)	\$43 (\$4,300)	1

Rollo 1 (100m) / MM 2

### Cordones uso extra rudo, 2 conductores, precio por metro en rollo de 100 m VOLTECK

Precios sin cambio



Código	Clave	Calibre	Distribuidor	Mayoreo	1/2 Mayoreo	Público	NC
40002	CAUR-210	2 x 10 AWG	\$52 (\$5,200)	\$57 (\$5,700)	\$62 (\$6,200)	\$69 (\$6,900)	1
40003	CAUR-212	2 x 12 AWG	\$34 (\$3,400)	\$37 (\$3,700)	\$42 (\$4,200)	\$45 (\$4,500)	1
40004	CAUR-214	2 x 14 AWG	\$23 (\$2,300)	\$25 (\$2,500)	\$28 (\$2,800)	\$30 (\$3,000)	1

Rollo 1 (100m) / MM 2

### Cordones dúplex flexibles SPT, precio por metro en carrete de 500 m VOLTECK

Precios sin cambio

Pág. 413



Código	Clave	Calibre	Distribuidor	Mayoreo	1/2 Mayoreo	Público	NC
40042	CDU-14-500	2 x 14 AWG	\$18 (\$9,000)	\$20 (\$10,000)	\$22 (\$11,000)	\$24 (\$12,000)	1
40043	CDU-16-500	2 x 16 AWG	\$11.50 (\$5,750)	\$12.50 (\$6,250)	\$14 (\$7,000)	\$15 (\$7,500)	1
40045	CDU-18-500	2 x 18 AWG	\$7.50 (\$3,750)	\$8 (\$4,000)	\$9 (\$4,500)	\$10 (\$5,000)	1

Carrete 1 (500 m) / MM 2

### Cordón dúplex flexible SPT, precio por metro en carrete de 300 m VOLTECK

Precios sin cambio



Código	Clave	Calibre	Distribuidor	Mayoreo	1/2 Mayoreo	Público	NC
40044	CDU-12-300	2 x 12 AWG	\$29 (\$8,700)	\$32 (\$9,600)	\$35 (\$10,500)	\$39 (\$11,700)	1

Carrete 1 (300 m) / MM 2

### Cordones dúplex flexibles SPT, precio por rollo de 100 m VOLTECK

Precios sin cambio

Pág. 413



Código	Clave	Calibre	Máster	Distribuidor	Mayoreo	1/2 Mayoreo	Público	NC
46066	CDU-12	2 x 12 AWG	NA	\$2,900 (\$29)	\$3,200 (\$32)	\$3,500 (\$35)	\$3,900 (\$39)	1
46067	CDU-14	2 x 14 AWG	NA	\$1,800 (\$18)	\$2,000 (\$20)	\$2,200 (\$22)	\$2,400 (\$24)	1
46068	CDU-16	2 x 16 AWG	NA	\$1,150 (\$11.50)	\$1,250 (\$12.50)	\$1,400 (\$14)	\$1,500 (\$15)	1
46069	CDU-18	2 x 18 AWG	6	\$750 (\$7.50)	\$800 (\$8)	\$900 (\$9)	\$1,000 (\$10)	1

Rollo 1 (100 m) / MM 2

### Cordones dúplex flexibles SPT, precio por rollo de 10, 12 y 20 m VOLTECK

Precios sin cambio



Código	Clave	Calibre	Metros por rollo	Máster	Distribuidor	Mayoreo	1/2 Mayoreo	Público	NC
40200	CDU-14-10	2 x 14 AWG	10 m	18	\$197 (\$19.70)	\$215 (\$21.50)	\$239 (\$23.90)	\$265 (\$26.50)	1
40201	CDU-16-12	2 x 16 AWG	12 m	18	\$152 (\$12.67)	\$167 (\$13.92)	\$185 (\$15.42)	\$205 (\$17.08)	1
40202	CDU-18-20	2 x 18 AWG	20 m	18	\$169 (\$8.45)	\$185 (\$9.25)	\$205 (\$10.25)	\$225 (\$11.25)	1

Rollo 6 / MM 2

### Cordón dúplex flexible, precio por metro en carrete de 500 m VOLTECK

Precios sin cambio

Pág. 413



Código	Clave	Calibre	Distribuidor	Mayoreo	1/2 Mayoreo	Público	NC
40046	CDU-12E-500	2 x 12 AWG	\$26 (\$13,000)	\$29 (\$14,500)	\$32 (\$16,000)	\$35 (\$17,500)	1

Carrete 1 (500 m) / MM 2

### Cordón dúplex flexible, precio por rollo de 100 m VOLTECK

Precios sin cambio



Código	Clave	Calibre	Distribuidor	Mayoreo	1/2 Mayoreo	Público	NC
46079	CDU-12E	2 x 12 AWG	\$2,600 (\$26)	\$2,900 (\$29)	\$3,200 (\$32)	\$3,500 (\$35)	1

Rollo 1 (100 m) / MM 2

### Tubos y codos conduit galvanizados de pared delgada EMT VOLTECK

Pág. 435

Electrical Metallic Tubing



Código	Clave	Medida	Largo	Espesor	Atado	Máster	Dist.	Mayoreo	1/2 Mayoreo	Púb.	NC
<b>Tubos conduit</b>											
47771	TC-1/2-DV	1/2"	3 m	1 mm	5	N/A	\$92	\$110	\$122	\$135	2
47772	TC-3/4-DV	3/4"	3 m	1 mm	5	N/A	\$125	\$149	\$165	\$182	2
47773	TC-1-DV	1"	3 m	1.5 mm	5	N/A	\$225	\$269	\$299	\$325	2
<b>Codos conduit a 90</b>											
47774	CODCO-1/2	1/2"	28 cm	1 mm	10	80	\$20	\$24	\$26	\$29	2
47775	CODCO-3/4	3/4"	30 cm	1 mm	10	60	\$27	\$32	\$36	\$39	2
47776	CODCO-1	1"	38 cm	1.6 mm	5	30	\$55	\$65	\$72	\$79	2

MM 0

### Tubos y codos conduit galvanizados de pared gruesa HW VOLTECK

Heavy Wall



Código	Clave	Medida	Largo	Espesor	Atado	Máster	Dist.	Mayoreo	1/2 Mayoreo	Púb.	NC
<b>Tubos conduit</b>											
45286	TC-1/2-GA	1/2"	3 m	1.6 mm	5	N/A	\$165	\$199	\$219	\$239	2
45287	TC-3/4-GA	3/4"	3 m	1.6 mm	5	N/A	\$199	\$239	\$265	\$289	2
45288	TC-1-GA	1"	3 m	1.8 mm	5	N/A	\$310	\$375	\$410	\$450	2
<b>Codos conduit a 90</b>											
49372	CODCO-1/2A	1/2"	32 cm	1.8 mm	10	60	\$29	\$35	\$38	\$42	2
49373	CODCO-3/4A	3/4"	37 cm	2 mm	10	60	\$39	\$47	\$52	\$57	2
49374	CODCO-1A	1"	45 cm	2.2 mm	5	30	\$69	\$82	\$92	\$99	2

MM 0

### Tubos conduit para mufa, 1 1/4" para Kit CFE VOLTECK

Pág. 434



Código	Clave	Medida	Largo	Espesor	Atado	Máster	Dist.	Mayoreo	1/2 Mayoreo	Púb.	NC
<b>Tubos conduit para mufa, 1 1/4"</b>											
47389	TC-1-1/4-GC	32 mm	1.5 m	1 mm	5	NA	\$127	\$152	\$169	\$185	2
47233	TC-1-1/4-G	32 mm	3 m	1 mm	5	NA	\$245	\$295	\$325	\$355	2

MM 0

### Tubo conduit de pared extra delgada, 1/2" Kit CFE VOLTECK



Código	Clave	Medida	Largo	Espesor	Atado	Máster	Dist.	Mayoreo	1/2 Mayoreo	Púb.	NC
<b>Tubo conduit de pared extra delgada, 1/2"</b>											
47232	TC-1/2-DA	13 mm	3 m	0.8 mm	5	NA	\$68	\$82	\$90	\$99	2

MM 0

## Tubos de PVC hidráulico serie inglesa de 3 m FOSET <sup>(PVC)</sup>

Pág. 523

Código	Clave	Ø Nominal	Dist.	Mayoreo	1/2 Mayoreo	Púb.	NC
<b>Cédula 40</b>							
43038	PVC-001	1/2"	\$38	\$45	\$49	\$55	2
43039	PVC-002	3/4"	\$55	\$65	\$72	\$79	2
Atado 10 / MM 0							
43040	PVC-003	1"	\$79	\$95	\$105	\$115	2
45520	PVC-004	1 1/4"	\$110	\$132	\$145	\$159	2
45521	PVC-005	1 1/2"	\$125	\$149	\$165	\$179	2
45522	PVC-006	2"	\$175	\$209	\$229	\$255	2
<b>RD 21</b>							
40081	PVC-101	1/2"	\$18	\$22	\$24	\$26	2
<b>RD 26</b>							
40082	PVC-102	3/4"	\$26	\$31	\$34	\$38	2
40083	PVC-103	1"	\$35	\$42	\$46	\$51	2
40084	PVC-104	1 1/4"	\$47	\$56	\$62	\$69	2
40085	PVC-105	1 1/2"	\$63	\$75	\$82	\$92	2
40086	PVC-106	2"	\$102	\$125	\$135	\$149	2

Atado 5 / MM 0

## Tubos de CPVC de 3 m FOSET <sup>(CPVC)</sup>

Pág. 524

Código	Clave	Ø Nominal	Dist.	Mayoreo	1/2 Mayoreo	Púb.	NC
<b>RD 13.5</b>							
45042	CPVC-001	1/2"	\$32	\$39	\$42	\$46	2
45043	CPVC-002	3/4"	\$49	\$59	\$65	\$72	2
Atado 10 / MM 0							
45044	CPVC-003	1"	\$85	\$105	\$115	\$125	2
<b>RD 11</b>							
45560	CPVC-004	1 1/4"	\$149	\$175	\$195	\$215	2
45561	CPVC-005	1 1/2"	\$215	\$255	\$285	\$315	2
45562	CPVC-006	2"	\$375	\$445	\$495	\$545	2

Atado 5 / MM 0

Precios sin cambio



## Tubos de PP-R de 4 m FOSET <sup>(PPR)</sup>

Pág. 527

Código	Clave	Ø Nominal	Dist.	Mayoreo	1/2 Mayoreo	Púb.	NC
49897	CV-001	1/2"	\$48	\$57	\$64	\$69	2
49898	CV-002	3/4"	\$72	\$87	\$95	\$105	2
Atado 10 / MM 00							
49899	CV-003	1"	\$125	\$150	\$165	\$179	2
45444	CV-004	1 1/4"	\$235	\$285	\$310	\$339	2
45445	CV-005	1 1/2"	\$355	\$425	\$465	\$515	2
45446	CV-006	2"	\$545	\$655	\$720	\$795	2

Atado 5 / MM 00

## Tubos rígidos de cobre de 3 m FOSET <sup>(COBRE)</sup>

Pág. 531

Código	Clave	Ø Nominal	Peso	Atado	Dist.	Mayoreo	1/2 Mayoreo	Púb.	NC
<b>Tipo "M"</b>									
41274	CC-001M	1/2"	0.9 kg	15	\$275	\$305	\$335	\$365	1
41275	CC-002M	3/4"	1.4 kg	10	\$459	\$505	\$555	\$615	1
41276	CC-003M	1"	2 kg	5	\$655	\$725	\$795	\$875	1
<b>Tipo "L"</b>									
41271	CC-001L	1/2"	1.2 kg	15	\$395	\$435	\$475	\$525	1
41272	CC-002L	3/4"	1.9 kg	10	\$619	\$685	\$745	\$825	1
41273	CC-003L	1"	2.9 kg	5	\$1,015	\$1,115	\$1,225	\$1,345	1
<b>Tipo "N"</b>									
48151	CC-001N	1/2"	0.5 kg	15	\$175	\$195	\$209	\$235	1
48152	CC-002N	3/4"	0.9 kg	10	\$325	\$355	\$395	\$435	1
48153	CC-003N	1"	1.4 kg	5	\$509	\$555	\$615	\$675	1

MM 2

4% PONDERADO



Precios sin cambio



## Tubos flexibles de cobre, rollo de 15 m FOSET <sup>(COBRE)</sup>

Pág. 531

Código	Clave	Ø Nominal	Peso	Máster	Dist.	Mayoreo	1/2 Mayoreo	Púb.	NC
48155	CC-001F	1/4"	1.7 kg	10	\$645	\$715	\$785	\$855	1
48156	CC-002F	5/16"	2.3 kg	10	\$895	\$985	\$1,085	\$1,195	1
48157	CC-003F	3/8"	2.6 kg	10	\$975	\$1,075	\$1,175	\$1,295	1
48158	CC-004F	1/2"	3.7 kg	5	\$1,395	\$1,535	\$1,685	\$1,850	1

Encogible 1 / MM 2

Precios sin cambio



## Calentadores solares de baja presión FOSET

5%

Pág. 508

Código	Clave	No. de tubos	No. de personas	Dist.	Mayoreo	1/2 Mayoreo	Púb.	NC
45274	CALE-8S	8	2	\$3,350	\$4,000	\$4,450	\$4,850	2
45270	CALE-10S	10	3	\$4,150	\$4,950	\$5,500	\$6,050	2
48287	CALE-12S	12	4	\$4,700	\$5,650	\$6,200	\$6,850	2
45272	CALE-15S	15	5	\$5,350	\$6,450	\$7,050	\$7,750	2
45273	CALE-20S	20	7	\$6,750	\$8,100	\$8,900	\$9,800	2

Caja 1 / MM 00



CALE-12S

## Calentadores solares de alta presión FOSET

5%

Pág. 508

Código	Clave	No. de tubos	No. de personas	Dist.	Mayoreo	1/2 Mayoreo	Púb.	NC
49965	CALE-12HS	12	4	\$9,850	\$11,850	\$13,000	\$14,250	2
49966	CALE-18HS	18	5	\$13,350	\$16,000	\$17,650	\$19,350	2

Caja 1 / MM 00



CALE-12HS

## Cilindros portátiles para gas LP FOSET

Precios sin cambio

Pág. 518

Código	Clave	Capacidad	Dist.	Mayoreo	1/2 Mayoreo	Púb.	NC
45887	CILG-2	2 kg (4.5 lb)	\$695	\$765	\$850	\$925	1
45888	CILG-4	4 kg (9 lb)	\$785	\$865	\$950	\$1,050	1
45889	CILG-6	6 kg (13 lb)	\$875	\$965	\$1,050	\$1,165	1
48107	CILG-9	20 lb (9 kg)	\$935	\$1,025	\$1,135	\$1,250	1
45890	CILG-20	20 kg (44 lb)	\$1,650	\$1,815	\$1,990	\$2,190	1
45891	CILG-30	30 kg (66 lb)	\$2,050	\$2,250	\$2,490	\$2,750	1

MM 00



## Sanitario de una pieza, con accesorios FOSET

2%

Pág. 542

Código	Clave	Dist.	Mayoreo	1/2 Mayoreo	Púb.	NC
49135	MUBA-450B	\$1,890	\$2,090	\$2,290	\$2,515	1

Caja 1 / MM 1





**Cadenas galvanizadas, precio por metro FIERO**

**Pág. 551**



Código	Clave	Espesor	Cubeta Inner	Dist.	Mayoreo	1/2 Mayoreo	Púb.	NC
<b>Precio por metro</b> (Referencia precio por cubeta)								
44269	CAGA-1/8	1/8"	75 m	\$21 (\$1,575)	\$27 (\$2,025)	\$30 (\$2,250)	\$33 (\$2,475)	3
44270	CAGA-3/16	3/16"	65 m	\$27 (\$1,755)	\$35 (\$2,275)	\$39 (\$2,535)	\$42 (\$2,730)	3
44271	CAGA-1/4	1/4"	35 m	\$46 (\$1,610)	\$59 (\$2,065)	\$65 (\$2,275)	\$72 (\$2,520)	3
44272	CAGA-5/16	5/16"	20 m	\$75 (\$1,500)	\$99 (\$1,980)	\$105 (\$2,100)	\$119 (\$2,380)	3
44273	CAGA-3/8	3/8"	10 m	\$112 (\$1,120)	\$145 (\$1,450)	\$159 (\$1,590)	\$175 (\$1,750)	3
44274	CAGA-1/2	1/2"	5 m	\$205 (\$1,025)	\$265 (\$1,325)	\$295 (\$1,475)	\$325 (\$1,625)	3

**En cubeta**



Código	Clave	Esp.	Caja	Bolsa Inner	Dist.	Mayoreo	1/2 Mayoreo	Púb.	NC
<b>Precio por bolsa</b> (Referencia precio por metro)									
40966	CAGA-1/8A1	1/8"	8	1 m	\$23 (\$23)	\$30 (\$30)	\$33 (\$33)	\$36 (\$36)	3
40967	CAGA-1/8A2		6	2 m	\$45 (\$22.50)	\$59 (\$29.50)	\$65 (\$32.50)	\$71 (\$35.50)	3
40968	CAGA-1/8A3	3/16"	4	3 m	\$66 (\$22)	\$85 (\$28.33)	\$95 (\$31.67)	\$105 (\$35)	3
40969	CAGA-3/16A1		8	1 m	\$30 (\$30)	\$39 (\$39)	\$43 (\$43)	\$47 (\$47)	3
40970	CAGA-3/16A2	3/16"	6	2 m	\$58 (\$29)	\$75 (\$37.50)	\$83 (\$41.50)	\$90 (\$45)	3
40971	CAGA-3/16A3		4	3 m	\$85 (\$28.33)	\$110 (\$36.67)	\$122 (\$40.67)	\$132 (\$44)	3
40972	CAGA-1/4A1	1/4"	6	1 m	\$50 (\$50)	\$65 (\$65)	\$71 (\$71)	\$79 (\$79)	3
40973	CAGA-1/4A2		4	2 m	\$98 (\$49)	\$129 (\$64.50)	\$139 (\$69.50)	\$155 (\$77.50)	3
40974	CAGA-1/4A3	5/16"	2	3 m	\$145 (\$48.33)	\$189 (\$63)	\$209 (\$69.67)	\$227 (\$75.67)	3
40975	CAGA-5/16A1		4	1 m	\$83 (\$83)	\$109 (\$109)	\$118 (\$118)	\$130 (\$130)	3
40976	CAGA-5/16A2	5/16"	2	2 m	\$160 (\$80)	\$209 (\$104.50)	\$227 (\$113.50)	\$252 (\$126)	3
40977	CAGA-5/16A3		2	3 m	\$237 (\$79)	\$309 (\$103)	\$335 (\$111.67)	\$375 (\$125)	3

**En bolsa**



**Cadenas pulidas, precio por metro FIERO**

**Pág. 551**

Código	Clave	Esp.	Cubeta Inner	Dist.	Mayoreo	1/2 Mayoreo	Púb.	NC
<b>Precio por metro</b> (Referencia precio por cubeta)								
44260	CAPU-1/8	1/8"	75 m	\$18 (\$1,350)	\$23 (\$1,725)	\$26 (\$1,950)	\$28 (\$2,100)	3
44261	CAPU-3/16	3/16"	65 m	\$24 (\$1,560)	\$31 (\$2,015)	\$34 (\$2,210)	\$38 (\$2,470)	3
44262	CAPU-1/4	1/4"	35 m	\$41 (\$1,435)	\$53 (\$1,855)	\$59 (\$2,065)	\$65 (\$2,275)	3
44263	CAPU-5/16	5/16"	20 m	\$69 (\$1,380)	\$89 (\$1,780)	\$99 (\$1,980)	\$109 (\$2,180)	3
44264	CAPU-3/8	3/8"	10 m	\$99 (\$990)	\$129 (\$1,290)	\$145 (\$1,450)	\$155 (\$1,550)	3
44265	CAPU-1/2	1/2"	5 m	\$179 (\$895)	\$235 (\$1,175)	\$255 (\$1,275)	\$279 (\$1,395)	3



**En cubeta**



**Concertinas, precio por rollo FIERO**

**Pág. 560**

Código	Clave	Ø Rollo	Dist.	Mayoreo	1/2 Mayoreo	Púb.	NC
<b>Alta seguridad</b>							
44920	PUCO-A45	45 cm	\$345	\$415	\$455	\$495	2
<b>Máxima seguridad</b>							
44921	PUCO-M45	45 cm	\$395	\$475	\$525	\$575	2

**Precio sin cambio**

**-5%**

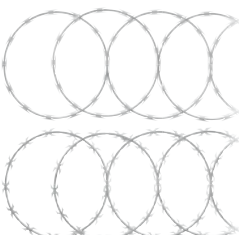

**Precios sin cambio**

**Alambre de púas galvanizado, precio por rollo FIERO**

**Pág. 560**

Código	Clave	Largo aprox.	Dist.	Mayoreo	1/2 Mayoreo	Púb.	NC
<b>Calibre 15.5 (1.6 mm)</b>							
44884	ALPU15-100	100 m	\$245	\$269	\$295	\$325	1
44887	ALPU15-300	300 m	\$645	\$715	\$785	\$855	1
44888	ALPU15-360	360 m	\$785	\$865	\$950	\$1,050	1

Rollo 1 / MM 0

<b>Calibre 12.5 (2.4 mm)</b>							
44885	ALPU12-30	300 m	\$965	\$1,065	\$1,165	\$1,285	1
44886	ALPU12-34	350 m	\$1,125	\$1,235	\$1,365	\$1,495	1

Rollo 1 / MM 1



**Precios sin cambio**

**Grapas para alambre de púas FIERO**

**Pág. 560**

Código	Clave	Medida	Dist.	Mayoreo	1/2 Mayoreo	Púb.	NC
<b>Galvanizadas</b>							
44513	GRA-1G	1"	\$425	\$515	\$565	\$615	2
44514	GRA-1-1/4G	1 1/4"					2
40128	GRA-1-1/2G	1 1/2"					2
<b>Negras</b>							
44511	GRA-1N	1"	\$375	\$445	\$495	\$545	2
44512	GRA-1-1/4N	1 1/4"					2



**Precios sin cambio**

**Alambre recocido, calibre 15, precio por kg FIERO**

**Pág. 560**

Código	Clave	Largo aprox.	Peso	Dist.	Mayoreo	1/2 Mayoreo	Púb.	NC
<b>Precio por kg</b> (Referencia precio por rollo)								
44458	ALRE-151	51 m	1 kg	\$32	\$35	\$39	\$42	1
<b>Rollo 10 / MM 2</b>								
44457	ALRE-160	1,117 m	20 kg	\$29 (\$580)	\$32 (\$640)	\$35 (\$700)	\$39 (\$780)	1
40051	ALRE-1560	3,350 m	60 kg	\$28 (\$1,680)	\$31 (\$1,860)	\$34 (\$2,040)	\$37 (\$2,220)	1

Rollo 1 / MM 2



**Precios sin cambio**

**Alambre galvanizado FIERO**

**Pág. 560**

Código	Clave	Calibre	Largo aprox.	Dist.	Mayoreo	1/2 Mayoreo	Púb.	NC
<b>Precio por rollo de 1 kg</b>								
44470	ALG-220	22	317 m	\$69	\$82	\$92	\$99	2
44469	ALG-200	20	262 m	\$59	\$70	\$78	\$85	2
44468	ALG-180	18	110 m	\$58	\$69	\$77	\$84	2
44467	ALG-160	16	68 m	\$56	\$67	\$75	\$82	2
44466	ALG-145	14.5	43 m	\$55	\$66	\$72	\$79	2
44465	ALG-125	12.5	30 m	\$52	\$62	\$69	\$75	2

Caja 5 kg / Máster 20 kg / MM 0

<b>Precio por rollo de 30 g</b>								
45112	ALG-220B	22	9.4 m	\$3	\$4	\$4.50	\$5	3
45115	ALG-200B	20	6.1 m					3
45116	ALG-180B	18	3.2 m					3
45117	ALG-160B	16	2 m					3
45121	ALG-145B	14.5	1.4 m					3





**Precios sin cambio**

Caja 20 / Máster 240 / MM 0

Clavos estándar con cabeza para **madera FIERO**

Precios sin cambio

Pág. 555

Cabeza avellanada (medidas de 2" a 5")



Código	Clave	Calibre	Clavos por blister aprox.	Largo	Distribuidor	Mayoreo	1/2 Mayoreo	Público
<b>Caja 25 kg / Precio por kg</b>								
44149	CLE-1	14.5	1,740	1"	\$52 (\$1,300)	\$62 (\$1,550)	\$69 (\$1,725)	\$75 (\$1,875)
44150	CLE-1-1/4	14.5	1,130	1 1/4"				
44151	CLE-1-1/2	13.5	900	1 1/2"				
MM 1								
44152	CLE-2	12	407	2"	\$26 (\$650)	\$31 (\$775)	\$35 (\$875)	\$38 (\$950)
44153	CLE-2-1/2	10.5	231	2 1/2"				
44154	CLE-3	9.5	160	3"				
44155	CLE-3-1/2	8	104	3 1/2"				
44156	CLE-4	6.5	68	4"				
44157	CLE-5	5.5	50	5"	NC 2			
MM 2								
<b>Caja 10 kg / Precio por kg</b>								
40166	CLE-2-10	12	407	2"	\$27 (\$270)	\$32 (\$320)	\$36 (\$360)	\$39 (\$390)
40167	CLE-2-1/2-10	10.5	231	2 1/2"				
40168	CLE-3-10	9.5	160	3"				
40169	CLE-3-1/2-10	8	104	3 1/2"				
40170	CLE-4-10	6.5	68	4"				
40171	CLE-5-10	5.5	50	5"	NC 2			
MM 2								
<b>Precio por bolsa de 1 kg</b>								
44813	CLE-1B	14.5	1,740	1"	\$53	\$63	\$70	\$77
44814	CLE-1-1/4B	14.5	1,130	1 1/4"				
44815	CLE-1-1/2B	13.5	900	1 1/2"				
Caja 10 kg / MM 1								
45021	CLE-2B	12	407	2"	\$28	\$33	\$37	\$40
45022	CLE-2-1/2B	10.5	231	2 1/2"				
45023	CLE-3B	9.5	160	3"				
45024	CLE-3-1/2B	8	104	3 1/2"				
45025	CLE-4B	6.5	68	4"				
45026	CLE-5B	5.5	50	5"	NC 2			
Caja 5 kg / Máster 20 / MM 2								

Clavos estándar sin cabeza para **madera FIERO**

Precios sin cambio

Pág. 555



Código	Clave	Calibre	Clavos por blister aprox.	Largo	Distribuidor	Mayoreo	1/2 Mayoreo	Público
<b>Precio por bolsa de 1 kg</b>								
44495	CLS-1	14.5	1,125	1"				
44496	CLS-1-1/2	14.5	1,000	1 1/2"				
44497	CLS-2	12.5	385	2"	\$53	\$63	\$70	\$77
44498	CLS-2-1/2	11	225	2 1/2"				
44499	CLS-3	10	180	3"				
Caja 10 kg / MM 1								
NC 2								
<b>Clavos alfilerillo para madera FIERO</b>								
Con cabeza  Sin cabeza 								
Pág. 555								
Código	Clave	Calibre	Clavos por blister aprox.	Largo	Distribuidor	Mayoreo	1/2 Mayoreo	Público
<b>Con cabeza precio por bolsa de 1 kg</b>								
44500	CLA-5/8	18	4,000	5/8"	\$65	\$78	\$85	\$95
44501	CLA-3/4	18	3,840	3/4"				
44502	CLA-1	17	2,960	1"				
Caja 10 kg / MM 0								
<b>Sin cabeza precio por bolsa de 1 kg</b>								
44503	CLA-5/8S	18	6,400	5/8"	\$65	\$78	\$85	\$95
44504	CLA-3/4S	18	5,100	3/4"				
44505	CLA-1S	17	2,850	1"				
Caja 10 kg / MM 0								
NC 2								

Clavos negros para **concreto FIERO**

Precios sin cambio

Pág. 555





HECHO EN MÉXICO

Código	Clave	Calibre	Clavos por blister aprox.	Largo	Distribuidor	Mayoreo	1/2 Mayoreo	Público
<b>Caja 25 kg / Precio por kg</b>								
44843	CLCG-3/4N	9	520	3/4"	\$66 (\$1,650)	\$79 (\$1,975)	\$87 (\$2,175)	\$95 (\$2,375)
44844	CLCG-1N	9	390	1"				
44845	CLCG-1-1/2N	9	270	1 1/2"				
44846	CLCG-2N	9	215	2"				
44847	CLCG-2-1/2N	9	170	2 1/2"				
44848	CLCG-3N	9	150	3"				
44849	CLCG-3-1/2N	8	100	3 1/2"				
44850	CLCG-4N	7	74	4"				
MM 0								
<b>Precio por bolsa de 1 kg</b>								
44130	CLC-3/4N	9	520	3/4"	\$68	\$82	\$89	\$99
44131	CLC-1N	9	390	1"				
44132	CLC-1-1/2N	9	270	1 1/2"				
44133	CLC-2N	9	215	2"				
44134	CLC-2-1/2N	9	170	2 1/2"				
44135	CLC-3N	9	150	3"				
44136	CLC-3-1/2N	8	100	3 1/2"				
44138	CLC-4N	7	74	4"				
Caja 5 kg / Máster 20 / MM 0								
NC 2								

Clavos galvanizados para **concreto FIERO**

Precios sin cambio

Pág. 555

HECHO EN MÉXICO

Código	Clave	Calibre	Clavos por blister aprox.	Largo	Distribuidor	Mayoreo	1/2 Mayoreo	Público
<b>Caja 25 kg / Precio por kg</b>								
44829	CLCG-3/4G	9	520	3/4"	\$80 (\$2,000)	\$96 (\$2,400)	\$105 (\$2,625)	\$115 (\$2,875)
44830	CLCG-1G	9	390	1"				
44831	CLCG-1-1/2G	9	270	1 1/2"				
44832	CLCG-2G	9	215	2"				
44833	CLCG-2-1/2G	9	170	2 1/2"				
44834	CLCG-3G	9	150	3"				
44835	CLCG-3-1/2G	8	100	3 1/2"				
44836	CLCG-4G	7	74	4"				
MM 0								
<b>Precio por bolsa de 1 kg</b>								
44120	CLC-3/4G	9	520	3/4"	\$82	\$99	\$109	\$119
44121	CLC-1G	9	390	1"				
44122	CLC-1-1/2G	9	270	1 1/2"				
44123	CLC-2G	9	215	2"				
44124	CLC-2-1/2G	9	170	2 1/2"				
44125	CLC-3G	9	150	3"				
44126	CLC-3-1/2G	8	100	3 1/2"				
44137	CLC-4G	7	74	4"				
Caja 5 kg / Máster 20 / MM 0								
NC 2								

### Mallas hexagonales de acero galvanizado, rollo de 45 m **FIERO**

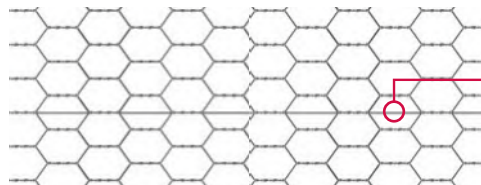
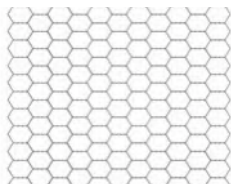

Precios sin cambio

Refuerzo de alambre cada 30 cm en calibres 22 y 20  
Mayor resistencia y firmeza

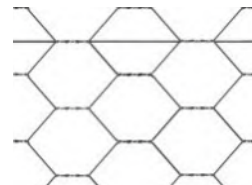

Pág. 558 **Abertura: 13 mm**

**Abertura: 25 mm**

**Abertura: 38 mm**

**Abertura: 50 mm**

Código:	44655	44656	44657	44658	44659	44660	44661	44662
Clave:	MAHE-1309	MAHE-2510	MAHE-2512	MAHE-2515	MAHE-2517	MAHE-3815	MAHE-3817	MAHE-5015
Altura:	0.90 m	1 m	1.2 m	1.5 m	1.7 m	1.5 m	1.7 m	1.5 m
Calibre	23	22		20		20		20
Número de refuerzos:	N/A	2	3	4	5	4	5	4
Peso aprox.:	16 kg	13 kg	16 kg	20 kg	23 kg	19 kg	21 kg	15 kg
Distribuidor:	\$1,250	\$890	\$1,090	\$1,290	\$1,490	\$1,250	\$1,450	\$935
Mayoreo:	\$1,375 NC 1	\$975 NC 1	\$1,190 NC 1	\$1,415 NC 1	\$1,650 NC 1	\$1,375 NC 1	\$1,590 NC 1	\$1,025 NC 1
1/2 Mayoreo:	\$1,515	\$1,075	\$1,315	\$1,550	\$1,790	\$1,515	\$1,750	\$1,135
Público:	\$1,665	\$1,185	\$1,450	\$1,715	\$1,985	\$1,665	\$1,925	\$1,250
Rollo:	1 / MM 00	1 / MM 00		1 / MM 00		1 / MM 00		1 / MM 00

### Mallas ciclónicas de acero galvanizado, rollo de 20 m, calibre 12.5 **FIERO**



Precios sin cambio

Pág. 558 **Abertura: 55 mm**

**Abertura: 63 mm**

**Abertura: 69 mm**

Código:	42949	42950	42951	42954	42955	42956	42957	42958	42959	42960	42961
Clave:	MACI-2552	MACI-2553	MACI-2554	MACI-2632	MACI-2633	MACI-2634	MACI-2690	MACI-2691	MACI-2692	MACI-2693	MACI-2694
Terminación:	Púa - Púa			Púa - Púa			Nudo	Púa	Púa - Púa		
Altura:	1.5 m	1.75 m	2 m	1.5 m	1.75 m	2 m	1 m	1.25 m	1.5 m	1.75 m	2 m
Peso aprox.:	39 kg	46 kg	51 kg	37 kg	38 kg	45 kg	21 kg	26 kg	31 kg	35 kg	40 kg
Distribuidor:	\$1,750	\$2,150	\$2,350	\$1,595	\$1,950	\$2,150	\$895	\$1,125	\$1,435	\$1,650	\$1,950
Mayoreo:	\$1,950 NC 1	\$2,350 NC 1	\$2,550 NC 1	\$1,750 NC 1	\$2,150 NC 1	\$2,350 NC 1	\$985 NC 1	\$1,250 NC 1	\$1,575 NC 1	\$1,815 NC 1	\$2,150 NC 1
1/2 Mayoreo:	\$2,115	\$2,595	\$2,850	\$1,950	\$2,350	\$2,595	\$1,085	\$1,350	\$1,750	\$1,995	\$2,350
Público:	\$2,350	\$2,850	\$3,150	\$2,150	\$2,595	\$2,850	\$1,195	\$1,495	\$1,915	\$2,195	\$2,595
Rollo:	1 / MM 0			1 / MM 0			1 / MM 0				

### Mallas borregueras de acero galvanizado, rollo de 50 m **FIERO**



Calibre interior 14.5

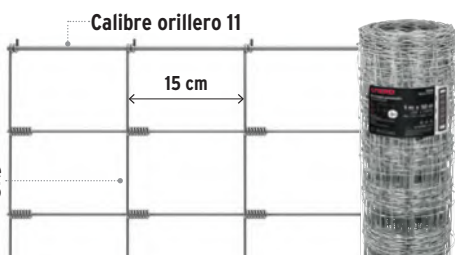

Precios sin cambio

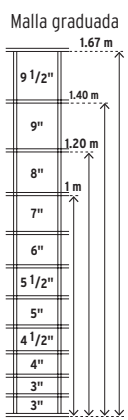

Código:	42859	42860	42861	42862
Clave:	MAGA-50X10	MAGA-50X12	MAGA-50X14	MAGA-50X16
Altura:	1 m	1.2 m	1.4 m	1.67 m
No. alambres longitudinales:	9	10	11	12
Peso aprox.:	23 kg	26 kg	28 kg	31 kg
Distribuidor:	\$985	\$1,125	\$1,265	\$1,395
Mayoreo:	\$1,085 NC 1	\$1,235 NC 1	\$1,395 NC 1	\$1,535 NC 1
1/2 Mayoreo:	\$1,195	\$1,365	\$1,535	\$1,685
Público:	\$1,315	\$1,495	\$1,685	\$1,855
Rollo:	1 / MM 0			

### Malla plafón de acero galvanizado, rollo de 22 m **FIERO**

- Calibre 26



Pág. 558

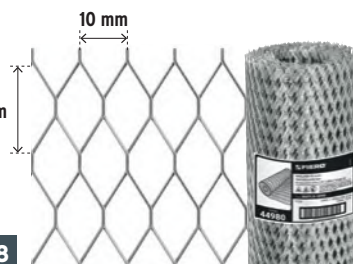

Precios sin cambio

### Malla mosquitera de acero galvanizado, rollo de 11 m **FIERO**

-5%

- Calibre 26



Pág. 558

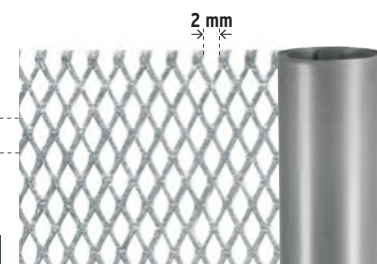

Código:	44980	46196
Clave:	MAPLA-5090	MAMO-09
Altura:	0.9 m	0.9 m
Peso aproximado:	8 kg	13 kg
Distribuidor:	\$595	\$1,190
Mayoreo:	\$655 NC 1	\$1,425 NC 2
1/2 Mayoreo:	\$725	\$1,575
Público:	\$795	\$1,725
Caja / Máster:	1 / MM 0	1 / MM 0